

Helixon-S



①



②

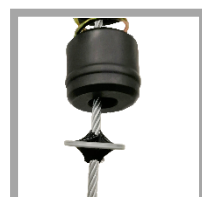

③









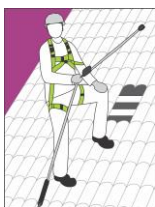
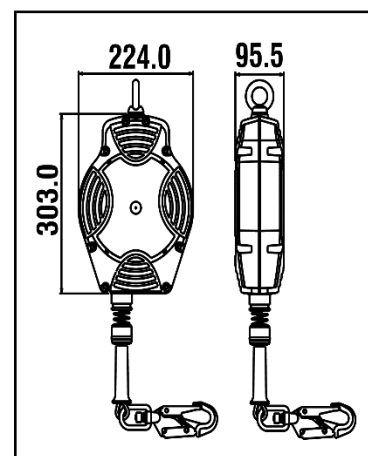

④



⑤



HS CODE
84798997
CARTON SIZE / PCS.
60 x 40 x 24 cm / 2
AET (EU) N°2777/10833-01/E01-03
Satra Technology Europe Ltd., N° 2777, Bracetown Business Park, Clonee, Dublin, D15YN2P, Ireland
MODULE D FI14/14003.02
SGS Fimko Oy, N°0598 Takomotie 8, 00380 HELSINKI, Finland

REF.	FA 20 402 15
LG.  KG	15 m
CE	EN 360:2002
MAT.  	Polyamide 6 - 30% fiber glass
	 STEEL Ø4.8 mm
	FA 50 101 17 / FA 50 203 20 with fall indicator x2
R(kN)	12 kN
	YES PPE-R/11.060
	8.01 KG



Longueur Poids maxi utilisateur
Length Max. user weight
Longitud Peso máximo del usuario
Lunghezza Peso Max. dell'utente
Länge Höchstgewicht des Benutzers

MAT.



Matière carter / câble
 Material of casing / wire rope
Material cárter / cable
 Material dei carter / cavo
Material Gehäuse / Seil

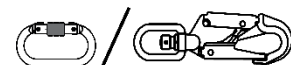

Matière connecteur haut / connecteur bas
 Material of top connector / bottom connector
Material conector alto / conector bajo
 Materiale connettore alto / connettore basso
Material oberes / unteres Verbindungselement



Nombre d'émerillons
 Number of swivels
Cantidad de eslabones giratorios
 Numero di tornichetti
Anzahl der Wirbel



Homologué pour le travail à proximité d'arêtes vives
 Approved for work near sharp edges
Homologado para trabajo cerca de aristas vivas
 Omologato per lavoro in prossimità di spigoli vivi
Zugelassen für Arbeiten in der Nähe scharfer Kanten